

LAMA INTERAMENTE BONIFICATA CON PUNTA BRUNITA,
IMPUGNATURA IN POLIPROPILENE

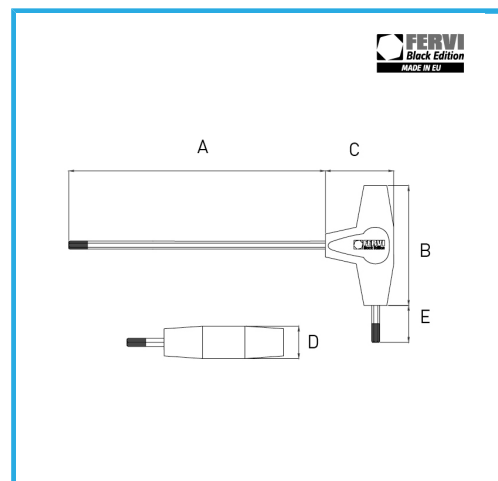

€5,60



Misura	5 mm
A	150 mm
B	70 mm
C	40 mm
D	21,3 mm
E	20 mm
Codice EAN	8012667303488

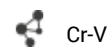

Cr-V



Cromata



Appendibile